

Stabilized oil-soluble
vitamin C derivative

VC-IP



Vitamin C



Whitening



Collagen
Synthesis



Anti-oxidant



DNA
Protection



UV
Protection



Stable

Oil-Soluble Vitamin C Derivative

VC-IP

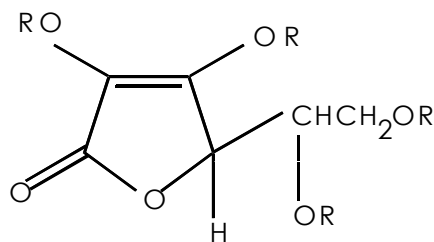

INCI Name : Ascorbyl Tetraisopalmitate

Vitamin C has many functions as a cosmetic ingredient, including skin lightening, promoting collagen synthesis and inhibiting lipid peroxidation. VC-IP (ascorbyl tetraisopalmitate) is stable at high temperatures and has good solubility in oils. VC-IP exhibits excellent percutaneous absorption and effectively converts into free vitamin C in the skin to perform various physiological functions. VC-IP is approved as a quasi-drug active in Japan (at 3%). It is also registered in Korea as a functional ingredient for skin lightening at 2% concentration.

Properties of VC-IP

- Superior percutaneous absorption
- Inhibits activity of intracellular tyrosinase and melanogenesis (whitening)
- Reduces UV-induced cell / DNA damage (UV protection / anti-stress)
- Prevents lipid peroxidation and skin aging (anti-oxidant)
- Good solubility in common cosmetic oils
- SOD-like activity (anti-oxidant)
- Collagen synthesis and collagen protection (anti-age)
- Heat- and oxidation-stable

Physical properties of NIKKOL VC-IP

Appearance	: Colorless to pale yellow liquid
Specific gravity (d^{20}_{20})	: 0.930 - 0.943
Refractive Index (n^{25D})	: 1.459 - 1.465



Vitamin C



Whitening



Collagen
Synthesis



Anti-oxidant



DNA
Protection



UV
Protection



Stable



Skin Lightening / Anti-Pigmentation

Inhibition of Melanogenesis

Various concentrations of VC-IP were added to cultured human melanoma cells (HM-3-KO). After 4 days of cultivation, the amount of melanin produced was measured by observation of the color tone of each cell pellet. As shown below, VC-IP effectively inhibited melanogenesis in human melanoma cells. Results were dose-dependent.

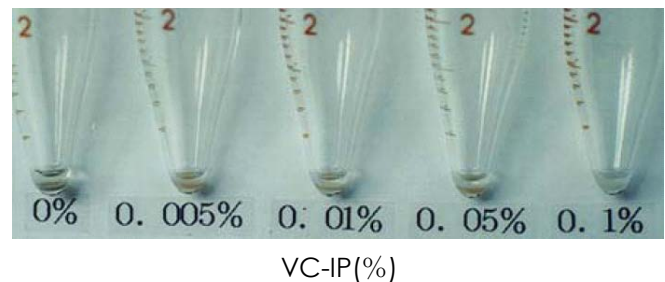
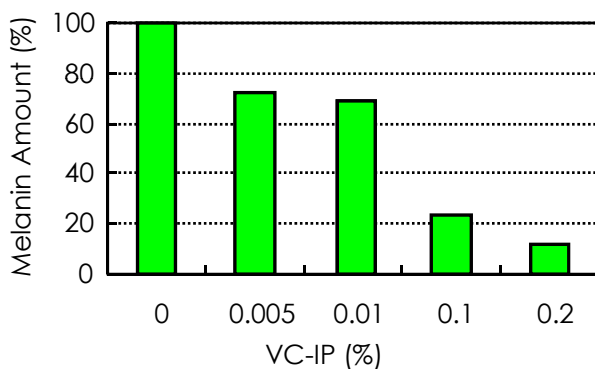

Melanogenesis Inhibition of VC-IP (in Human Cells)

Inhibition of Intracellular Tyrosinase Activity

VC-IP was added into mouse melanoma cells (B16-4A5) at various concentrations. After a 72-hour cultivation, the cells were dissolved and extracted. L-Dopa was then added to the extract. After 60 minutes at 37°C, the amount of dopachrome formed by the activity of tyrosinase was evaluated by measuring its absorbance at 540 nm. Figure below shows that at a concentration of 0.02% and above VC-IP inhibited the activity of intracellular tyrosinase.

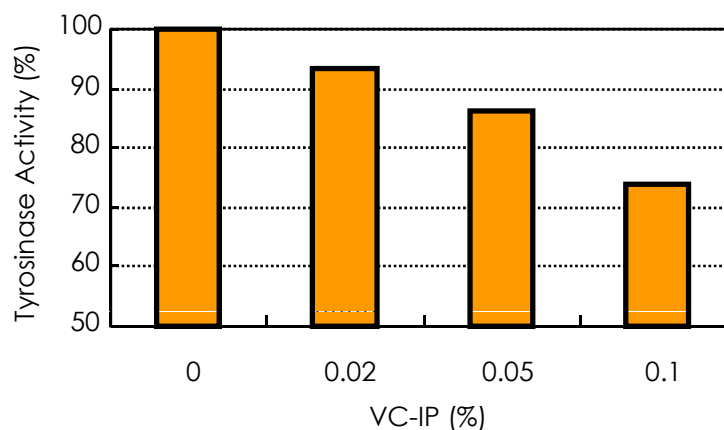

Inhibitory Effect of VC-IP on Intracellular Tyrosinase Activity

Clinical In-Vivo Study on VC-IP (3%)



Number of volunteers: 30

Testing site: Inner side of volunteer's upper arm

Testing period: 3 weeks

Procedure: For the first step of the test, minimal erythema dose (MED) of each volunteer is measured using solar simulator. Briefly, 6 doses of UV ray are irradiated to the inner side of right upper arm. After 24 hours from irradiation, MED is judged. For the second step, 1.5 MED of UV ray is irradiated on the inner side of left upper arm of each volunteer in order to make pigmentation. Sample application is started just after irradiation. Sample is applied twice a day during test period. Sample application sites are randomly changed in every volunteer in order to do justice.

Results

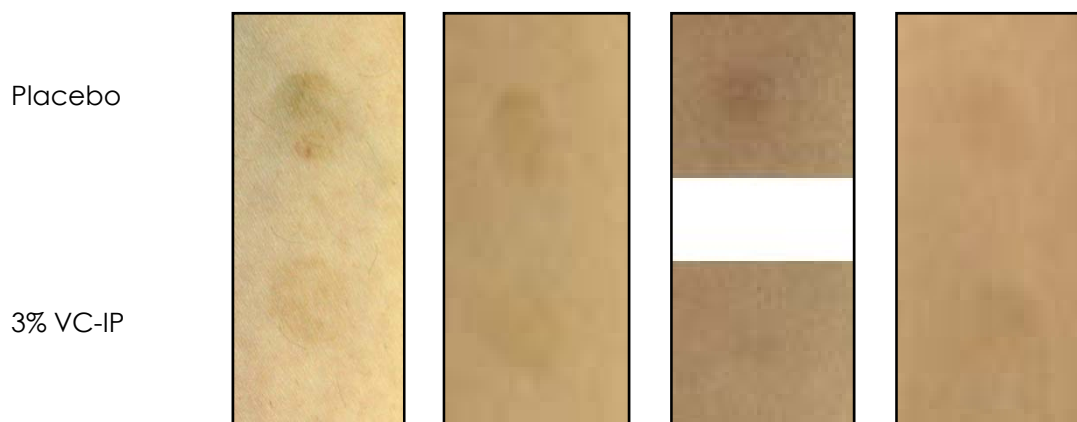

Formulations used in the evaluation

	BLANK	TEST Sample (VC-IP 3%)
(A)		
NIKKOL BC-20TX (Ceteth-20)	1.0	1.0
NIKKOL GO-440 (Sorbeth-40 Tetraoleate)	0.5	0.5
NIKKOL MGS-B (Glyceryl Stearate)	1.0	1.0
Cetanol	5.0	5.0
NIKKOL Squalane	10.0	10.0
NIKKOL ICM-R (Isocetyl Myristate)	6.0	6.0
NIKKOL Trifat S-308 (Triethylhexanoin)	3.0	3.0
NIKKOL Jojoba Oil	1.0	1.0
Dimethicone	0.2	0.2
Tocopherol	0.1	0.1
Propylparaben	0.1	0.1
(B)		
VC-IP	-	3.0
Distilled Water	-	-
(C)		
Xanthan Gum (2% soln.)	5.0	5.0
1,3-BG	5.0	5.0
Metylparaben	0.2	0.2
Distilled Water	61.9	58.9

Skin Lightening / Anti-Pigmentation



Other Clinical In-Vivo Studies with VC-IP

Reduction of UV-induced pigmentation

Test period: 56 days.
Concentration: 2%.



Before

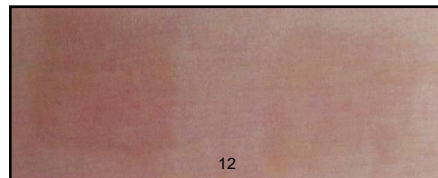

After 56 days

Control

VC-IP (2%)



Before



After 56 days

Control

VC-IP (2%)

Pigmentation reduction effect

Test period: 16 weeks.
Concentration: 10%.
Result: complete removal of pigmentation (age spot).



Before



After



Anti-oxidant

Singlet Oxygen Scavenging Ability

VC-IP can scavenge singlet oxygen and prevent it from oxidizing L-Dopa to dopachrome. In order to evaluate this ability, UVB was used to irradiate mixture of Hematoporphyrin and L-Dopa with VC-IP/ L-ascorbic acid to produce singlet oxygen and subsequently dopachrome. The amount of produced dopachrome was then determined through its absorbance. Using this measured value, the singlet oxygen scavenging ability of each VC-IP/ L-ascorbic acid was calculated. As shown in figure below, VC-IP and L-ascorbic acid scavenged 80% and 78% of singlet oxygen, respectively.

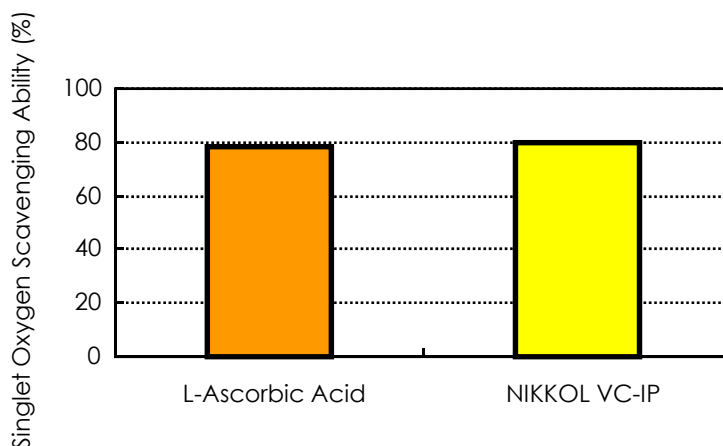

Singlet Oxygen Scavenging Ability of VC-IP
(UVB Irradiation: 4 hours, Concentration: 2.5×10^{-4} mol/L, Amount of dopachrome was determined through its absorbance at 475nm.)

Inhibition of Sebum Oxidation

VC-IP (10% in mineral oil) was applied to the inner forearms of 6 volunteers. UVB (2.05 J/cm²) was used to irradiate the test site 4 hours after application. Then the production rate of squalene peroxide was measured as an indicator of sebum oxidation. As shown below, VC-IP inhibited the production of squalene peroxide at the same level as the control without UVB irradiation.

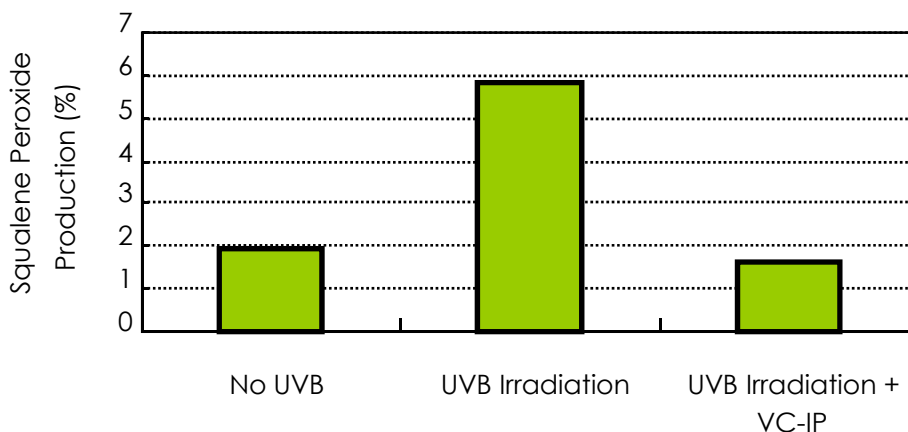

Inhibition of Sebum Oxidation



Anti-oxidant

Protection of Cell damage induced by H₂O₂

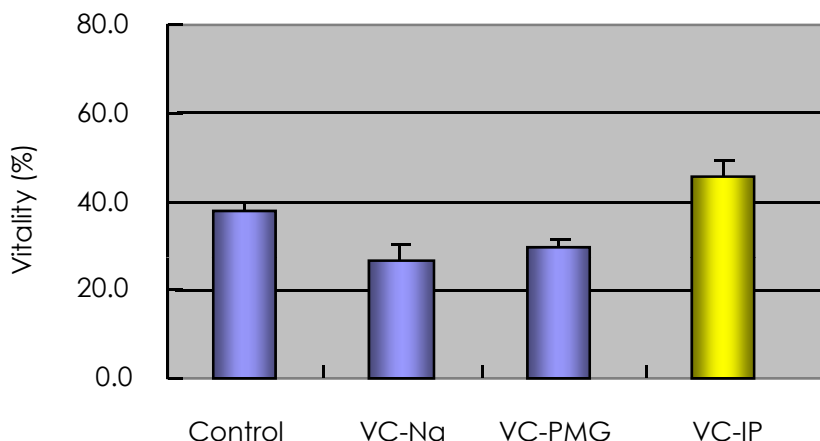

HaCaT keratinocytes were treated with various 100 mM of various vitamin C derivatives for 24 h. After treatment of 20 mM H₂O₂ for 2 h, cell survival was estimated. Significance: * p<0.05.

Protection of Cell damage induced by t-BHP (tert-butylhydroperoxide)

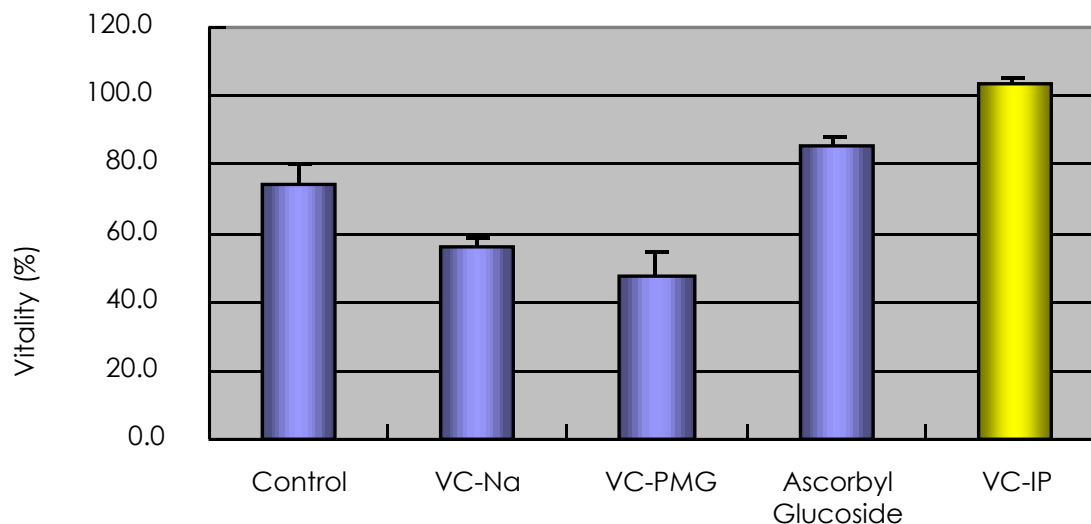

HaCaT keratinocytes were treated with various 100 mM of various Vitamin C derivatives for 24 h. After treatment of 1.0 mM of t-BHP for 4 h, cell survival was estimated. Significance: ** p<0.01.

SOD-Like Activity

The amount of Diformazan formed by the reduction of Nitro Blue Terazolium by superoxide anions (O₂⁻) was determined by measuring the absorbance (NBT reduction method). This was then used as the indicative value for SOD-like activity of VC-IP. Before the measurement, 0.1 mL of VC-IP was added to 2 mL of the sample. As a result, VC-IP inhibited 40% of Diformazan formation. This confirms the SOD-like activity of VC-IP.

VC-IP protects skin from UVB

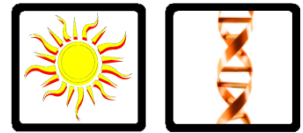

Protection of DNA from UVB irradiation

When cells are exposed to UVB rays, a cancer suppressor, p53 protein, is activated in response to DNA damage. The amount of expressed p53 was measured as an indicator of the amount of damage to DNA. Human fibroblasts (NB1RGB); UVB (0.1J/cm²). VC-IP significantly inhibited the expression of p53.

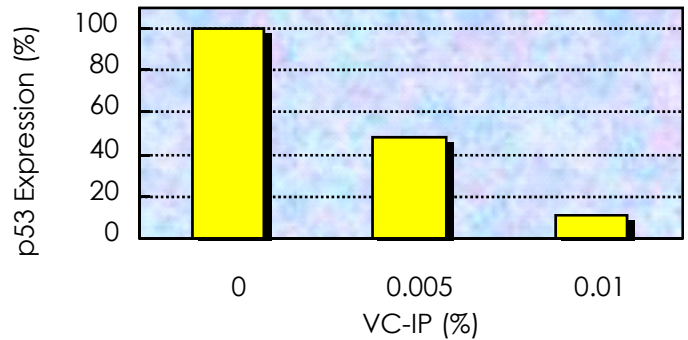

p53 Expression (Western Blot)

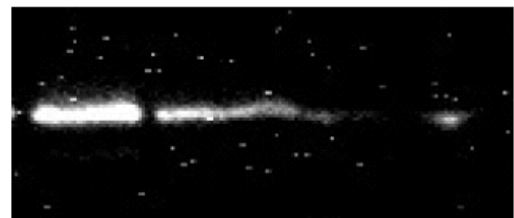

0 0.005 0.01 (%)

VC-IP (%)

Reduction of cell damage caused by UV Irradiation

VC-IP and L-ascorbic acid were added at the concentration of 10μmol/L to epidermal cells. The cells were then irradiated with UVB. After a 24-hour cultivation, cell survival rate was measured by WST-1 assay. Protective effect of VC-IP was higher than that of L-ascorbic acid due to the fact that the conversion rate of VC-IP into the cells is higher than that of pure ascorbic acid.

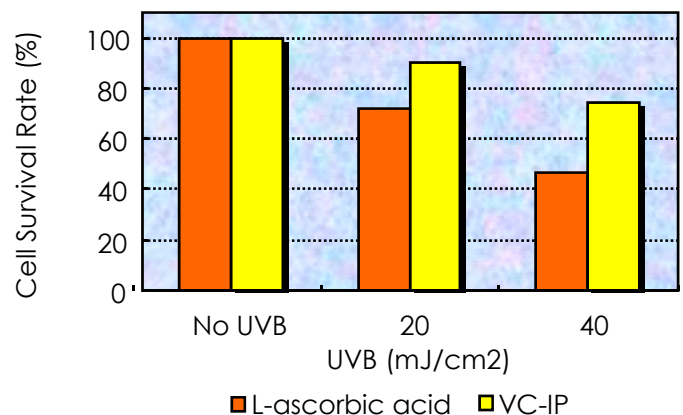

VC-IP protects skin from UVB



Comet Assay Test

The comet assay, also called the 'Single Cell Gel Assay', is the technique to detect DNA damage and repair at the level of single cells. The comet assay or single cell gel electrophoresis assay is based on the alkaline lysis of labile DNA at sites of damage. 'Comet Assay' is one of the most popular tests of DNA damage detection (e.g., single- and double-strand breaks, oxidative-induced base damage, and DNA-DNA/DNA-protein cross linking) by electrophoresis, developed in recent years.

Comet Assay has very high sensitivity to detect DNA damage.

Idea

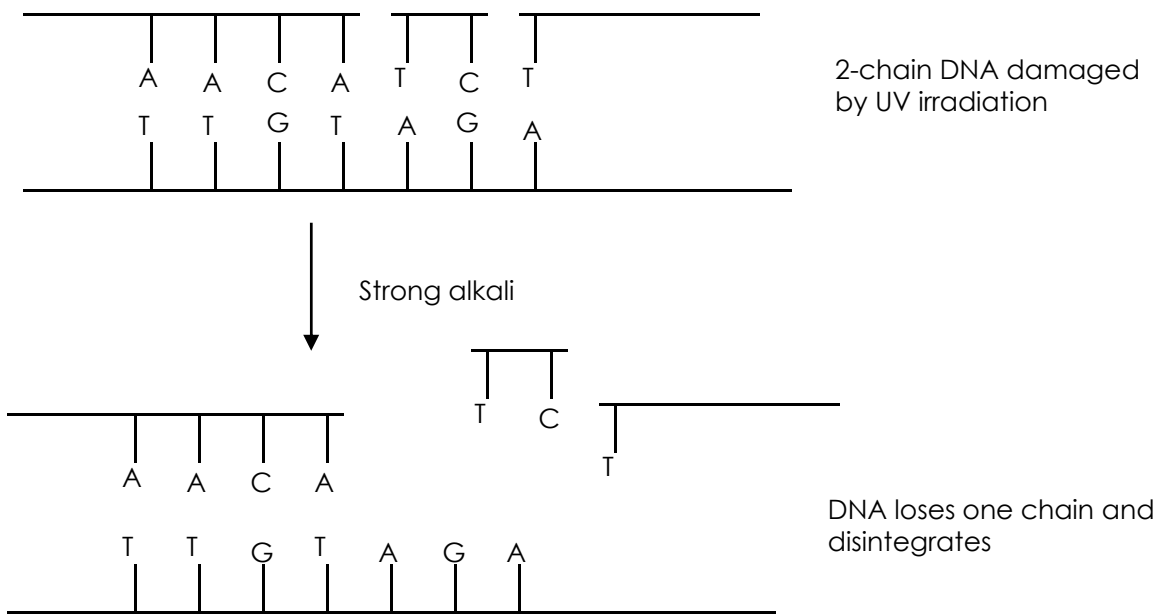

Test method

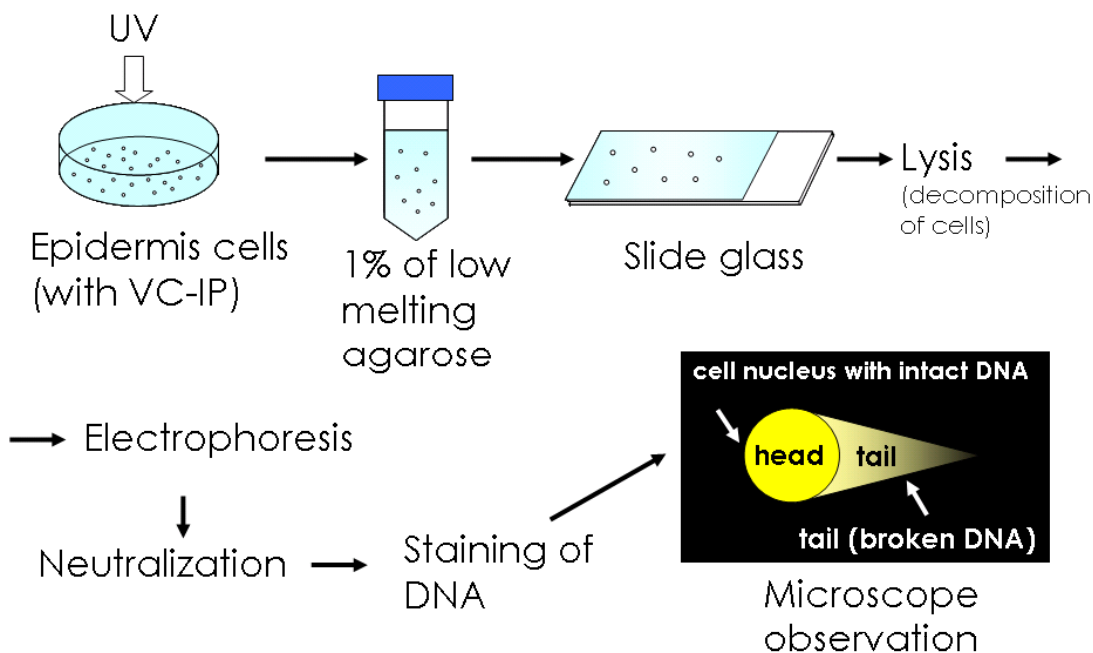

VC-IP protects skin from UVB

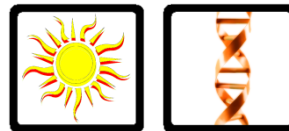

Suppression of DNA damage induced by UVB (Comet Assay test)

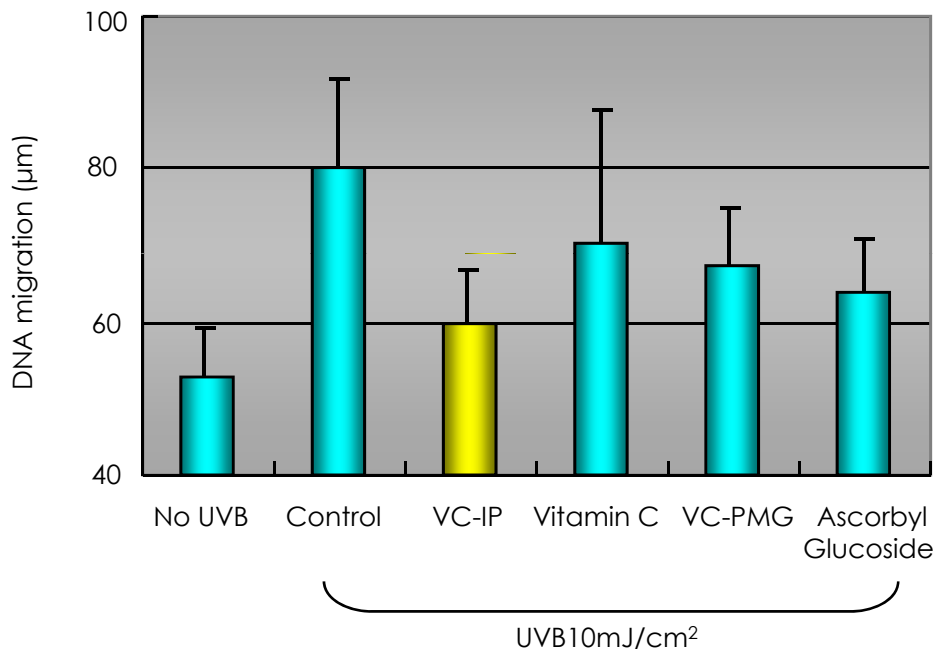

DNA damage was evaluated by the comet assay. HaCaT keratinocytes which were treated with VC derivatives for 24 h, were exposed to UVB at 100 mJ/cm².



DNA damage was evaluated by the comet assay. HaCaT keratinocytes which were treated with VC-IP for 24 h, were exposed to UVB at 10 mJ/cm². Cells are stained with etidium bromide.

VC-IP protects skin from UVA

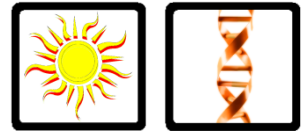

Inhibition of keratinocytes' DNA damage induced by UVA

The light parts on the pictures (taken 1 hour after of UVA irradiation) indicate 8-hydroxyguanosine, an index of DNA damage. The application of VC-IP inhibits the release of 8-hydroxyguanosine, thereby protecting the cell against UVA damage.



No treatment

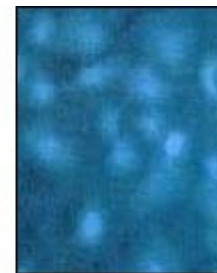

VC-IP (80 μM)

Protection of cell damage induced by UVA

Microscopic pictures of keratinocytes 24 hours after irradiation. VC-IP treatment reduces cell death by 31.5%.



No UVA

UVA

UVA + VC-IP

Inhibition of DNA Fragmentation induced by UVA

Control

Treated with VC-IP

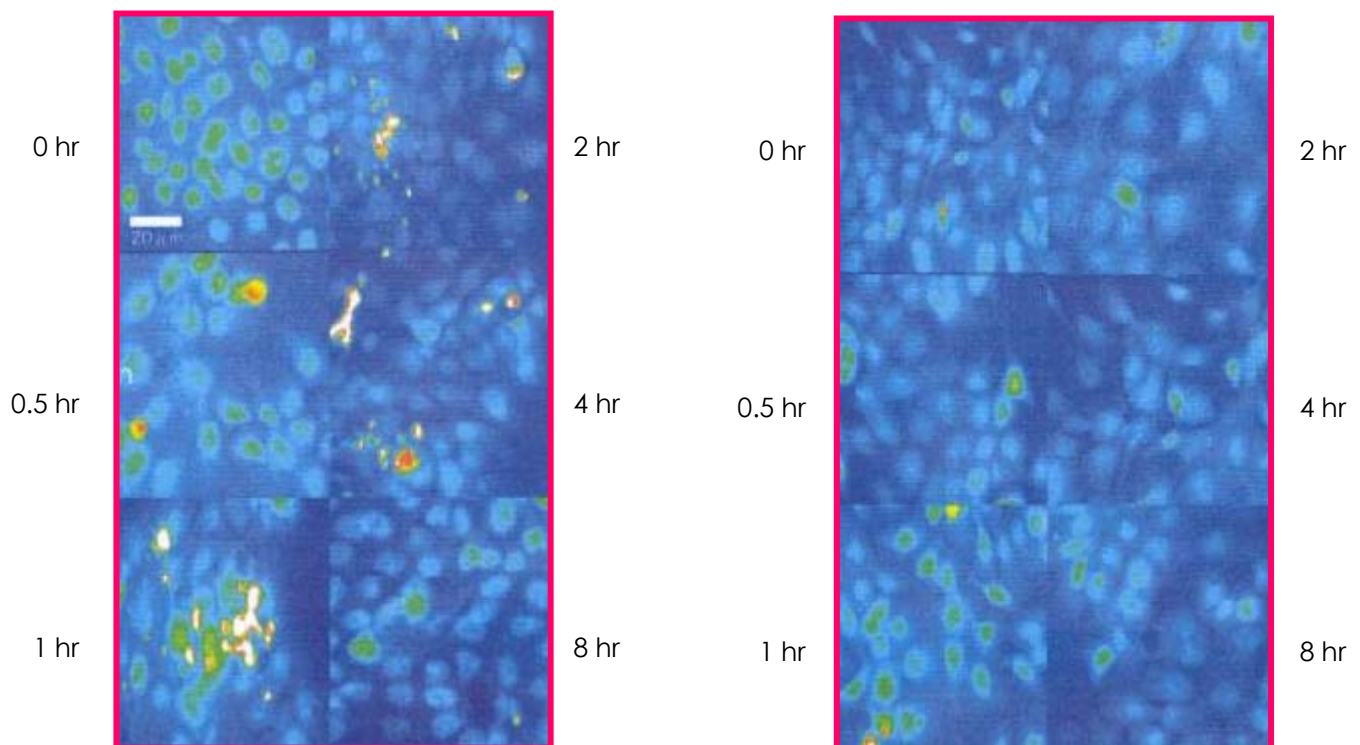

HaCaT cells were treated with 80 μM VC-IP. After UVA irradiation, DNA fragmentation was detected by nick end labeling method (TUNEL). VC-IP significantly suppressed DNA fragmentation (shown with fluorescent staining).

*UVA dosage of the test on this page is 100 mJ/cm².



Anti-aging Properties

Cell Revitalizing Activity / Cell Proliferation

VC-IP was added at various concentrations to human fibroblasts (NB1RGB). After 3 days of cultivation, the cell growth rate was measured by MTT reduction assay. As shown below, VC-IP proliferated human fibroblasts. And the result was dose-dependent.

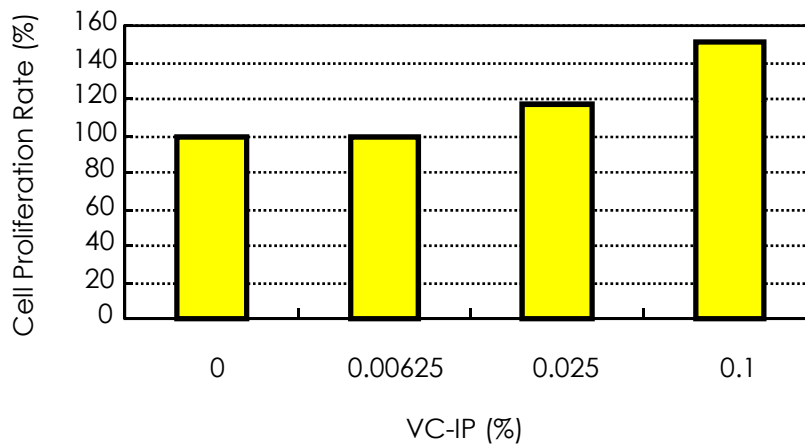

Cell Revitalizing Activity of VC-IP

Promotion of Collagen Synthesis

Proline involved in collagen synthesis was labeled by ^3H and added to human dermal fibroblasts (NHDF) with various concentrations of VC-IP/L-ascorbic acid and cultivated for 24 hours. Then collagen fractions were obtained. The amount of ^3H taken into the collagen fraction was measured by using a liquid scintillation counter and slot blotter. As shown below, VC-IP significantly promoted collagen synthesis.

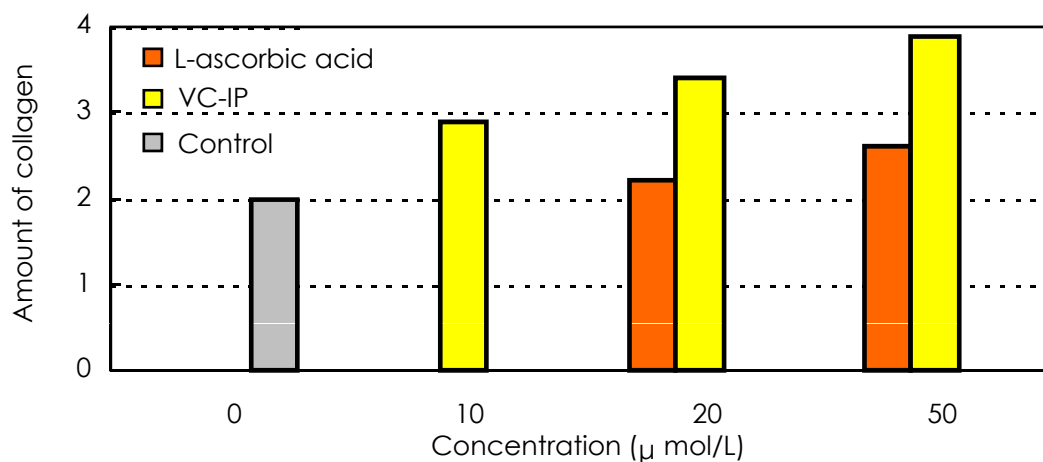

Promotion of Collagen Synthesis

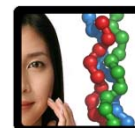

Anti-aging Properties

Inhibition of Activity of Collagen Degrading Enzyme

VC-IP was added at concentrations of 10-50 μ mol/L to human dermal fibroblasts (NHDF). After a 48-hour cultivation, secreted material was obtained. The activity of two types of collagen degrading enzymes, MMP-2 (72kDa) and MMP-9 (92kDa), in the secreted material were evaluated by gelatin zymography. VC-IP drastically inhibited the activity of both MMP-2 and MMP-9. The inhibitory effect was considerably higher than that of L-ascorbic acid.

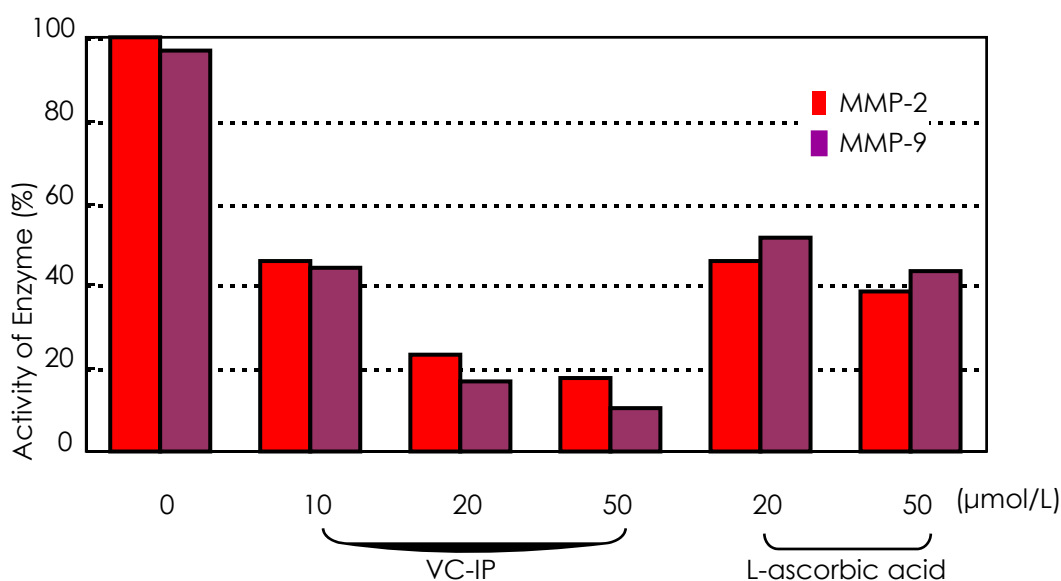

Inhibition of Collagen Degrading Enzyme Activity



Superior Skin Penetration

Percutaneous Absorption of VC-IP

Percutaneous absorption of VC-IP was measured with a tissue section isolated from human skin. VC-IP showed superior penetration ability into the epidermis.

VC-IP is an oil-soluble liquid and has a high affinity for the skin. This seems to explain the excellent percutaneous absorption. This ability can be enhanced when VC-IP is used together with Polyolprepolymer-2 (PP-2, Bertek Pharmaceuticals).

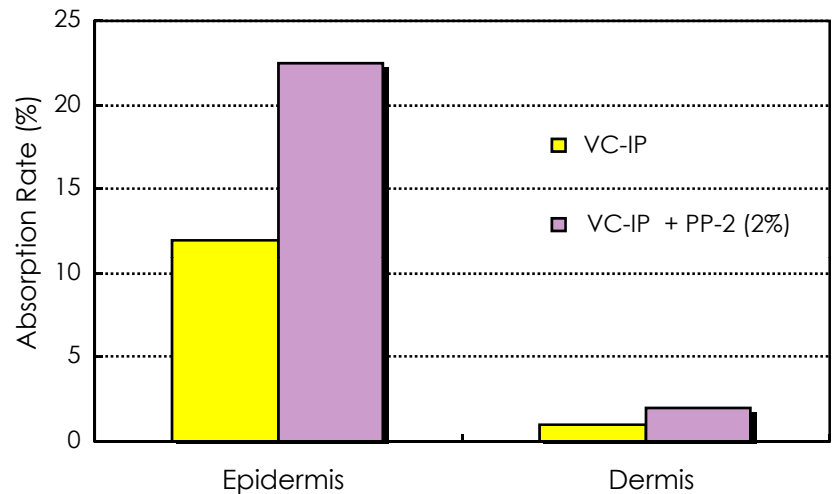

Percutaneous Absorption of VC-IP

Efficient Absorption into Human Dermal Fibroblasts

The absorption of VC-IP into human dermal fibroblasts (NHDF) was measured as a concentration of ascorbic acid 2 hours after adding VC-IP. As shown below, the intake of ascorbic acid into the skin after the addition of VC-IP was considerably higher than that after the addition of L-ascorbic acid by itself. It was proven that VC-IP was rapidly broken down into ascorbic acid at a high conversion rate.

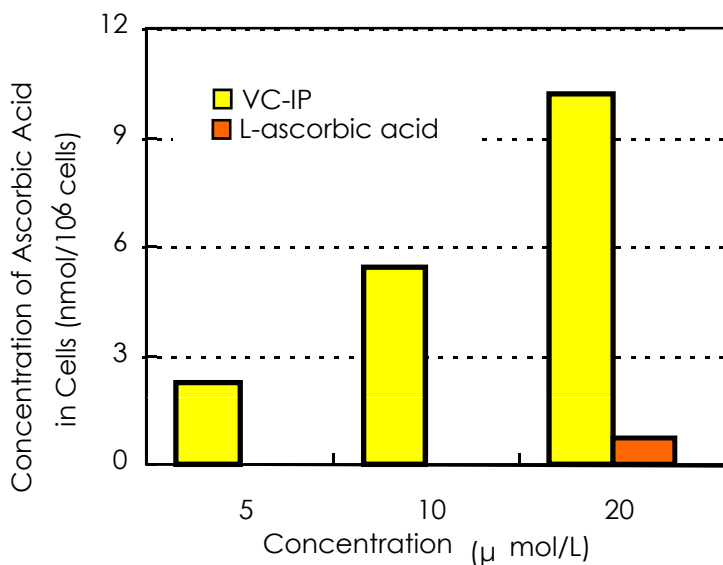

Absorption of VC-IP into Human Fibroblasts



Superior Skin Penetration

Evaluation of human skin penetration of VC-IP and Ascorbyl Glucoside

Subjects: 8.

Test site: forearm.



Cream with 10% VC-IP

Cream with 10% Ascorbyl Glucoside



Application time: 1 hour



Tape stripping from test sites is performed 20 times

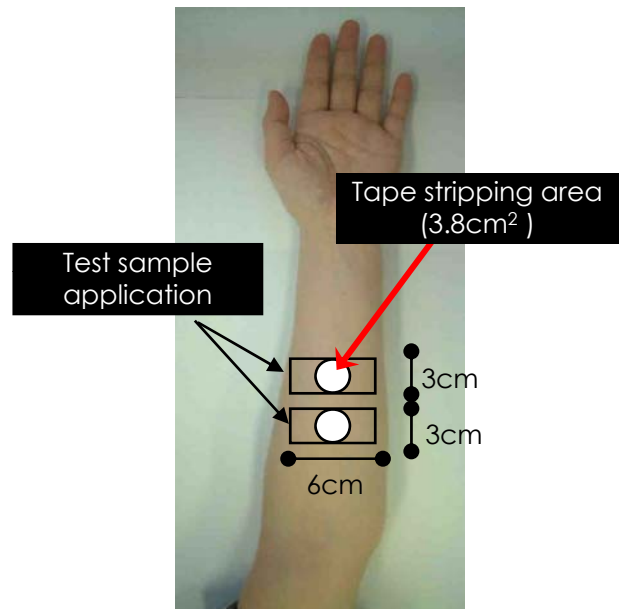

Amount of VC-IP and Ascorbyl Glucoside collected by tape stripping is evaluated by HPLC

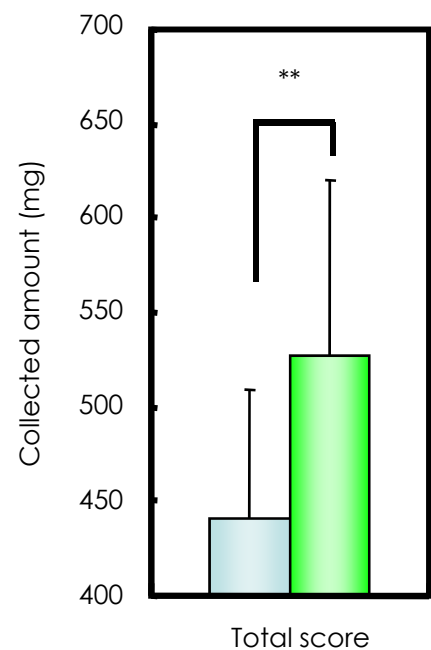
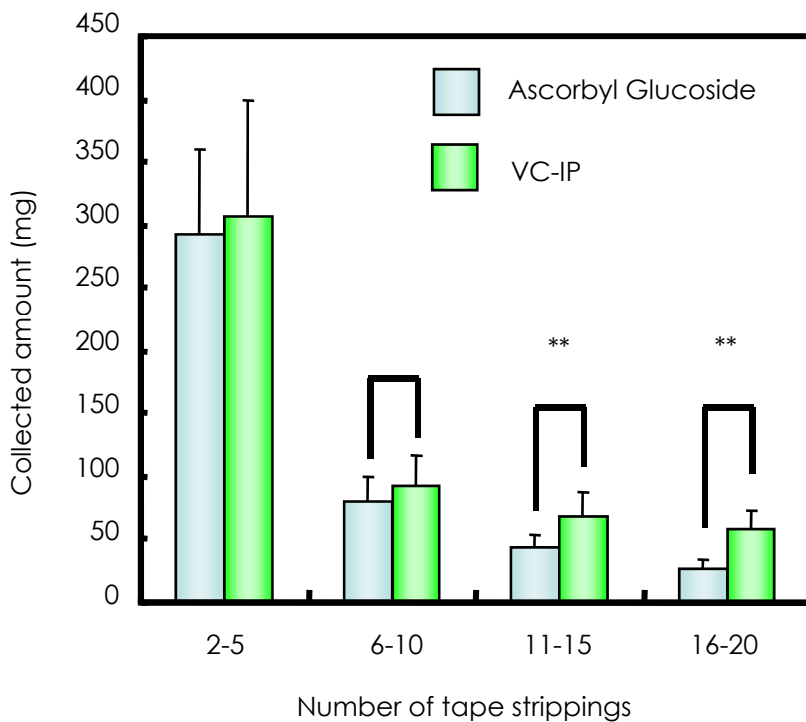

** : p < 0.05

VC-IP showed higher skin penetration than Ascorbyl Glucoside.

NIKKO CHEMICALS CO., LTD.

1-4-8 NIHONBASHI-BAKUROCHO, CHUOKU, TOKYO, 103-0002, JAPAN Email: inter@nikkol.co.jp www.nikkol.co.jp

Solubility of VC-IP

The solubility of VC-IP in various cosmetic raw materials was measured at 25, 50 and 75°C. VC-IP is soluble in most oils, whether polar oil or non-polar, except polyhydric alcohols.

Concentration of VC-IP (wt%)	5			10			50		
	25	50	70	25	50	70	25	50	70
Temperature (°C)									
Cosmetic Ingredient									
Glycerin	I	I	I	I	I	I	I	I	I
Propylene Glycol	I	I	I	I	I	I	I	I	I
1,3-Butylene Glycol	I	I	I	I	I	I	I	I	I
Ethanol	S	S	S	S	S	S	I	S	S
Propyleneglycol Monocaprylate	S	S	S	S	S	S	S	S	S
Castor Oil	S	S	S	S	S	S	S	S	S
Triethylhexanoin	S	S	S	S	S	S	S	S	S
Olive Oil	S	S	S	S	S	S	S	S	S
Cetyl Ethylhexanoin	S	S	S	S	S	S	S	S	S
Mineral Oil	S	S	S	S	S	S	S	S	S

S : Soluble I : Insoluble

Instructions for Use

VC-IP has superior stability compared with other vitamin C derivatives. However, it may discolor under some specific conditions. Design preparations in the pH range not higher than 6.0. The use of chelating agents and anti-oxidants (tocopherol) in the formulation is recommended because they are effective to prevent discoloration. Since contact with water may induce oxidation of VC-IP, add surfactants with long chain polyoxyethylenes to stabilize the system, strengthening the interfacial membrane. Avoid heating for long periods of time.

Stability of VC-IP in cream

Stability of VC-IP assay and pH of cream (10% aq. solution) at 45 degrees Celsius x 3 months.

Emulsifier: glyceryl stearate.
VC-IP: 3.3%. Oil phase: 10%.
PH adjustment: citric acid / sodium citrate.

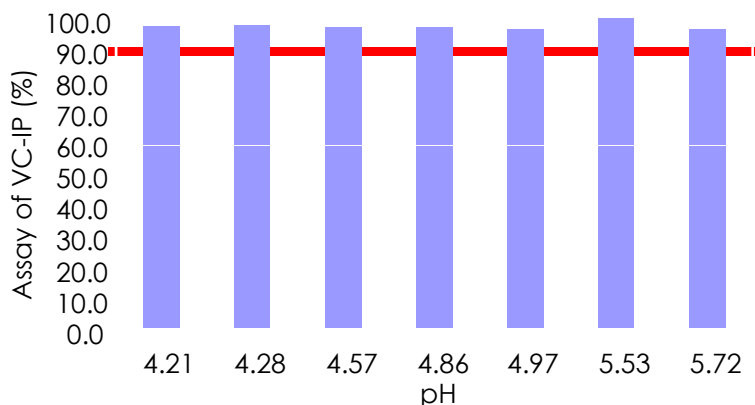

Usage of NIKKOL VC-IP

NIKKOL VC-IP is a relatively stable vitamin C derivative. However, try to abide by the following rules while dealing with this product.

- Use processing not exceeding pH 6.
- Add product into formulation right before the adjustment.

Formulations

Skin Lotion 1

	Ingredient	wt.%
A	NIKKOL Lecinol SH50 (Hydroxylated Lecithin)	2.0
	NIKKOL VC-IP (Ascorbyl Tetraisopalmitate)	0.05
B	1,3-Butylene Glycol	10.0
	Methyl Paraben	q.s.
	Distilled Water	to make 100.0
C	Pemulen TR-2 (2% aq.soln.) (Acrylates/C10-30 Alkyl Acrylate Crosspolymer)	5.0
	Distilled Water	5.0
D	Triethanolamine	0.1
	Citric Acid	0.05
	Sodium Citrate	0.20
	Distilled Water	9.65

<Procedure>

Mix A at room temperature. Heat B to 70°C and dissolve, then cool to room temperature. While stirring A, add B and dissolve. Dissolve D to C separately in advance. Add A+B to C+D and stir until uniform.

Formulations

Skin Lotion 2

	Ingredient	wt.%
A	NIKKOL PBC-34 (POE(20)POP(4) Cetyl Ether)	0.6
	NIKKOL VC-IP (Ascorbyl Tetraisopalmitate)	0.1
	NIKKOL Macadamia Nuts Oil	0.1
B	Distilled Water	to make 100
C	1,3-Butylene Glycol	5.0
	Dipropylene Glycol	5.0
	Methyl Paraben	q.s.
	Distilled Water	20.0
D	Sodium Hyaluronate (1% aq. sol.)	5.0
	Distilled Water	10.0

<Procedure>

Heat A and B to 70°C and dissolve. While stirring A, add B gradually. Cool to 50°C while stirring, and add C. Keep stirring while cooling to 35°C.

Formulations

Anti-Acne Lotion

	Ingredient	wt.%
A	NIKKOL PEN-4630 (POE(30)POP(6) Decyltetradecyl Ether)	1.0
	NIKKOL HCO-60 (POE(60) Hydrogenated Castor Oil)	0.5
	NIKKOL VC-IP (Ascorbyl Tetraisopalmitate)	0.1
	d-Camphor	0.02
	l-Menthol	0.05
	Salicylic Acid	0.01
	Glycerin	5.0
B	Antiphlogistic Agent	q.s.
	EDTA	0.05
	Distilled Water	to make 100

<Procedure>

Heat A and B to 70°C and dissolve.

While stirring A, add B by small portions.

Keep stirring while cooling to 35°C.

Formulations

Moisturizer

	Ingredient	wt.%
A	NIKKOL PEN-4630 (POE(30)POP(6) Decyltetradecyl Ether)	2
	NIKKOL VC-IP (Ascorbyl Tetraisopalmitate)	0.5
	d- δ -Tocopherol	0.2
B	Distilled Water	50
C	1,3-Butylene Glycol	5
	Dipropylene Glycol	2
	FUCOGEL 1000PP	1.5
	Xanthan Gum (2% aq. sol)	5
	Methyl Paraben	q.s.
	Distilled Water	to make 100

<Procedure>

Heat A and B to 70°C and dissolve. While stirring A, add B by small portions. Cool to 50°C while stirring, and add C. Keep stirring while cooling to 35°C

Formulations

Beautifying Oil (Anti-aging)

	Ingredient	wt.%
A	NIKKOL ICM-R (Isocetyl Myristate)	10.0
	NIKKOL Macadamia Nut Oil	5.0
	NIKKOL Jojoba Oil	5.0
	NIKKOL VC-IP (Ascorbyl Tetraisopalmitate)	1.0
	Vitamin E	0.1
	NIKKOL Olive Squalane	to make 100

<Procedure>

Mix A at room temperature.

Formulations Emollient Cream

	Ingredient	wt.%
A	NIKKOL BC-20TX (Ceteth-20)	1.0
	NIKKOL GO-440 (PEG-40 SORBITAN TETRAOLEATE)	0.5
	NIKKOL MGS-B (GLYCERYL STEARATE)	1.0
	NIKKOL VC-IP (Ascorbyl Tetraisopalmitate)	1.0
	Cetanol	5.0
	Olive Squalane	10.0
	NIKKOL ICM-R (Isocetyl Myristate)	6.0
	NIKKOL Trifat S-308 (Trioctanoin)	3.0
	NIKKOL Jojoba Oil	1.0
	Methylpolysiloxane (350 mm ² / s)	0.2
	Vitamin E	0.1
	Propyl Paraben	q.s.
B	Methyl Paraben	q.s.
	1,3-Butylene Glycol	5.0
	Xanthan Gum	0.1
	Citric Acid	0.1
	Sodium Citrate	0.4
	Distilled Water	to make 100
C	FUGOGEL 1000PP	1.0
	Distilled Water	4.0

<Procedure>

Heat and dissolve A and B respectively.

While keeping 80°C, add B to A little by little with stirring and emulsify.

Cool with stirring and add C at 50°C. Cool to 35°C.

Formulations

Cream

	Ingredient	wt.%
A	NIKKOL Nikkolipid 81S	2.5
	NIKKOL Olive Squalane	8.0
	NIKKOL Trifat S-308 (Trioctanoin)	6.0
	NIKKOL N-SP (Cetyl Palmitate)	5.0
	NIKKOL VC-IP (Ascorbyl Tetraisopalmitate)	1.0
	Beeswax	1.5
	NIKKOL Behenyl Alcohol 65	1.0
	Stearyl Glycyrrhetinate	0.2
	4- <i>tert</i> -Butyl-4'-methoxy-dibenzoylmethane	0.3
	Decamethyl Cyclopentasiloxane	4.0
	Methyl Polysiloxane	0.3
	Propyl Paraben	q.s.
B	Xanthan Gum (2% aq. sol.)	10.0
	Glycerin	3.0
	Phenoxyethanol	0.2
	Methyl paraben	q.s.
	Refined water	to make 100
C	Hamamelis Extract	0.2
	Distilled Water	4.8

<Procedure>

Heat A and B to 70°C and dissolve.

While stirring A, add B by small portions. Stir in homomixer.

Cool to 50°C while stirring, and add C. Keep stirring while cooling to 35°C.

Formulations

Deodorant Base (Roll-on Type)

	Ingredient	wt.%
A	NIKKOL Nikkolipid 81S	1.0
	NIKKOL VC-IP (Ascorbyl Tetraisopalmitate)	0.5
	Mineral Oil	5.0
	NIKKOL Olive Squalane	2.0
B	Xanthan Gum (2% aq. sol.)	3.6
	Guar gum (2% aq. sol.)	11.4
	1,3-Butylene Glycol	2.0
	Methyl Paraben	q.s.
	Distilled Water	to make 100

<Procedure>

Heat A and B to 70°C and dissolve.

While stirring B in homomixer, add A by small portions.

Keep stirring while cooling to 35°C.

By adding fragrance and other components to this base, the deodorant product can be manufactured.

Formulations

Deodorant base (Stick Type)

	Ingredient	wt.%
A	NIKKOL SL-10 (Sorbitan Laurate)	1.0
	Paraffin Wax (135F)	2.0
	Mineral Oil (#70)	13.8
	NIKKOL Dextrin Palmitate	0.1
	Stearyl Alcohol	4.0
	Ceresin	3.0
	NIKKOL Lecinol S-10 (Hydrogenated Lecithin)	1.0
	Talc	40.0
	Decamethyl Cyclopentasiloxane	34.1
B	NIKKOL VC-IP (Ascorbyl Tetraisopalmitate)	1.0

<Procedure>

Heat A and B to 70°C and dissolve.

While stirring A in homomixer, add B by small portions.

Fill into stick container and keep stirring while cooling to 35°C.

By adding fragrance and other components to this base, the deodorant product can be manufactured.



**Visit to Chemical-navi.com
Skin Care Business Total Support Site**

<https://www.chemical-navi.com/english/index.html>

NIKKOL GROUP

NIKKO CHEMICALS CO., LTD.

1-4-8 NIHONBASHI-BAKUROCHO, CHUOKU, TOKYO, 103-0002, JAPAN

Email: inter@nikkol.co.jp

<http://www.nikkol.co.jp/en/>